

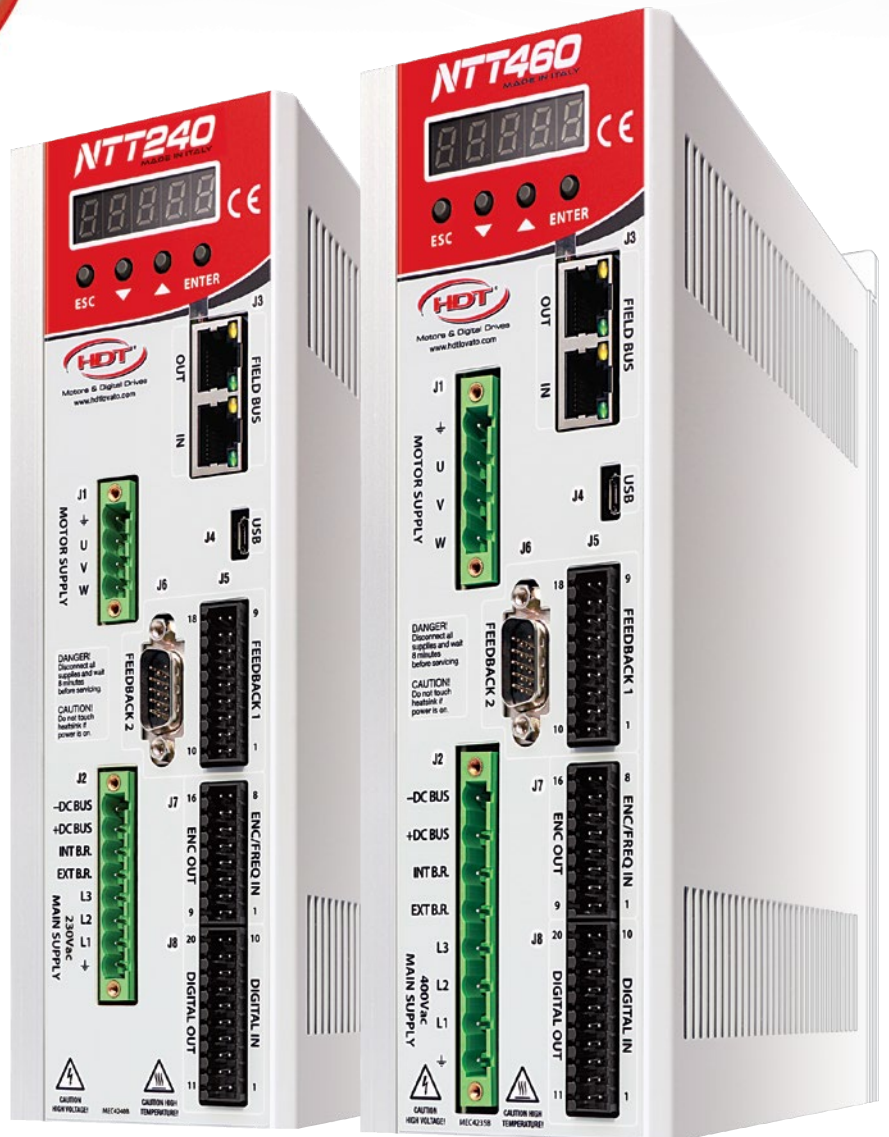

Motors & Digital Drives



NTT

Digital servodrive solutions

The spirit of motion control.

Developed for modern automation needs, the NTT servodrive is designed around a new CPU that allows great performances and the real-time connectivity via fieldbus like EtherCat, ProfiNet, ProfiBus, CanOpen and Modbus. The NTT drives distinguish themselves thanks to the great flexibility in motor control, whether they are AC or DC, synchronous or asynchronous, rotary or linear. The many features of these drives offer a solution for most applications, whether they are speed control, torque, but also positioning, electronic gear, electronic shaft and pressure control.

Terminals easy to wire

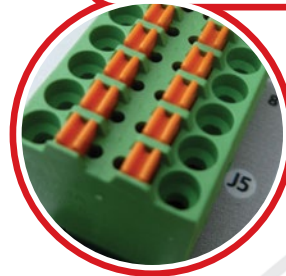

230VAC
UP TO 3 kW

Keypad

- Keypad with 5 Digit display

Control Mode

- FieldBus
- Pulses/Direction
- 16 bit Analog reference

Encoder Output Line Drive 5V

- Main Feedback Repetition.
- Pulses/Direction Repetition.
- Simulated encoder, up to 16384 ppr + Zero Index

Software Applications

- Speed control
- Sensorless speed control
- Torque control and torque limit
 - Multi-positioner
 - Electronic gear
 - Electronic cam
- Pressure control

Software Filters

- Notch filter
- Iq filter
- Digital Input Filter
- Observer

Protection Circuits

- Motor short-circuit
- Over/undervoltage of power supply
- Drive Overtemperature
 - Feedback fault
- Rated Current limit
- Motor temperature thermal image
- Other protections

Brake

- Electronic brake management

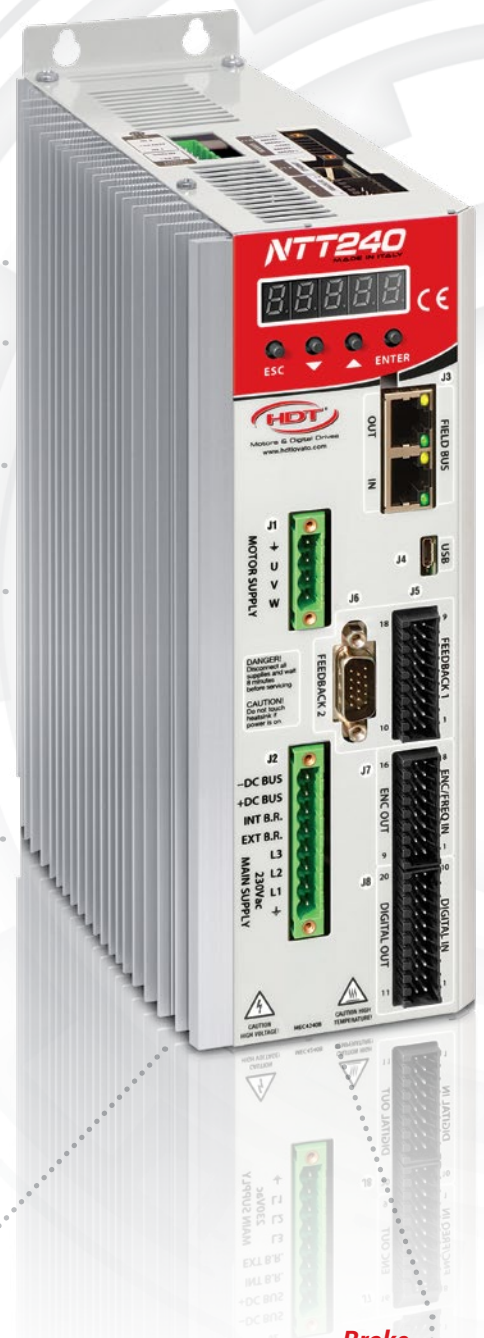

Main Features

Integrated safety STO

Input for safety stop STO, SIL3, Cat.0, according to IEC61800-5-2:2007

400VAC
UP TO 40kW



Communication Ports

- Micro USB 2.0
- RJ45 Ethernet port*
- RS485 for proprietary fieldbus*

Ethernet Port

- for Industry 4.0*
- for remote control via router*
- for diagnostic*



Optional Fieldbuses

- EtherCat CoE
- ProfiNet RT and IRT
- ProfiBus DPV0
- CanOpen CiA 402
- ModBus RTU
- ModBus TCP*

EtherCAT

PROFINET

PROFIBUS

CANopen

Modbus

Main Feedback

- Sensorless
- Hall's sensors
- Incremental Encoder 5V LD
- Inc. Enc. with Hall's sensors
- Absolute Encoder SSI

Optional Feedback

- Resolver
- Absolute Encoder SSI + SinCos*
- Absolute Encoder HyperFace + SinCos*

Auxiliary Encoder

- Incremental Encoder 5V LD

Controllable Motors

- AC brushless servomotor (Synchronous):
 - rotary type
 - linear type
- Induction AC servomotor (Asynchronous)
 - V/Hz control
 - FOC control (sensorless or with encoder)
- DC permanent magnet motor

Analog I/O

- 3 Inputs:
 - 1 x 16bit input
 - 2 x 12Bit inputs
- 2 programmable outputs

Digital I/O

- 8 PNP programmable optoinsulated inputs
- 3 PNP programmable non optoinsulated inputs
- 6 PNP programmable optoinsulated outputs
- 1 programmable clean contact relay
- 1 frequency input



Sizes in current and overall dimensions

NTT240

SIZES		1.5	3	6	10
Power supply	V_{AC}	230 V_{AC} 1Ph - 3Ph			230 V_{AC} 3Ph
Min/Max supply voltage	V_{AC}	230 $V_{AC} \pm 15\%$ - 50/60Hz			
DC Min/Max supply voltage	V_{DC}	200 $V_{DC} \div 360 V_{DC}$			
Rated current	A_{rms}	1,5	3	6	10
Peak current	A_{rms}	3	6	12	20
Rated output power	KW	0,5	1	1,5	3
Internal braking resistor		NO	NO	YES	YES
External optional braking resistor output		YES			
EMC internal filter *		YES			
Logic supply	V_{DC}	24 $V_{DC} \pm 20\%$			
Dynamic forced ventilation		NO			YES
Dimensions		T0		T1	T2
Weight	Kg	2		2,4	2,6
Safety functions		STO - Safe Torque Off: IEC61800-5-2:2007 SIL3 Cat.0: EN61508:2001 (EN954-1:1996)			

* = (EMC 61800-3 cat. C2 - C3)

Dimensions

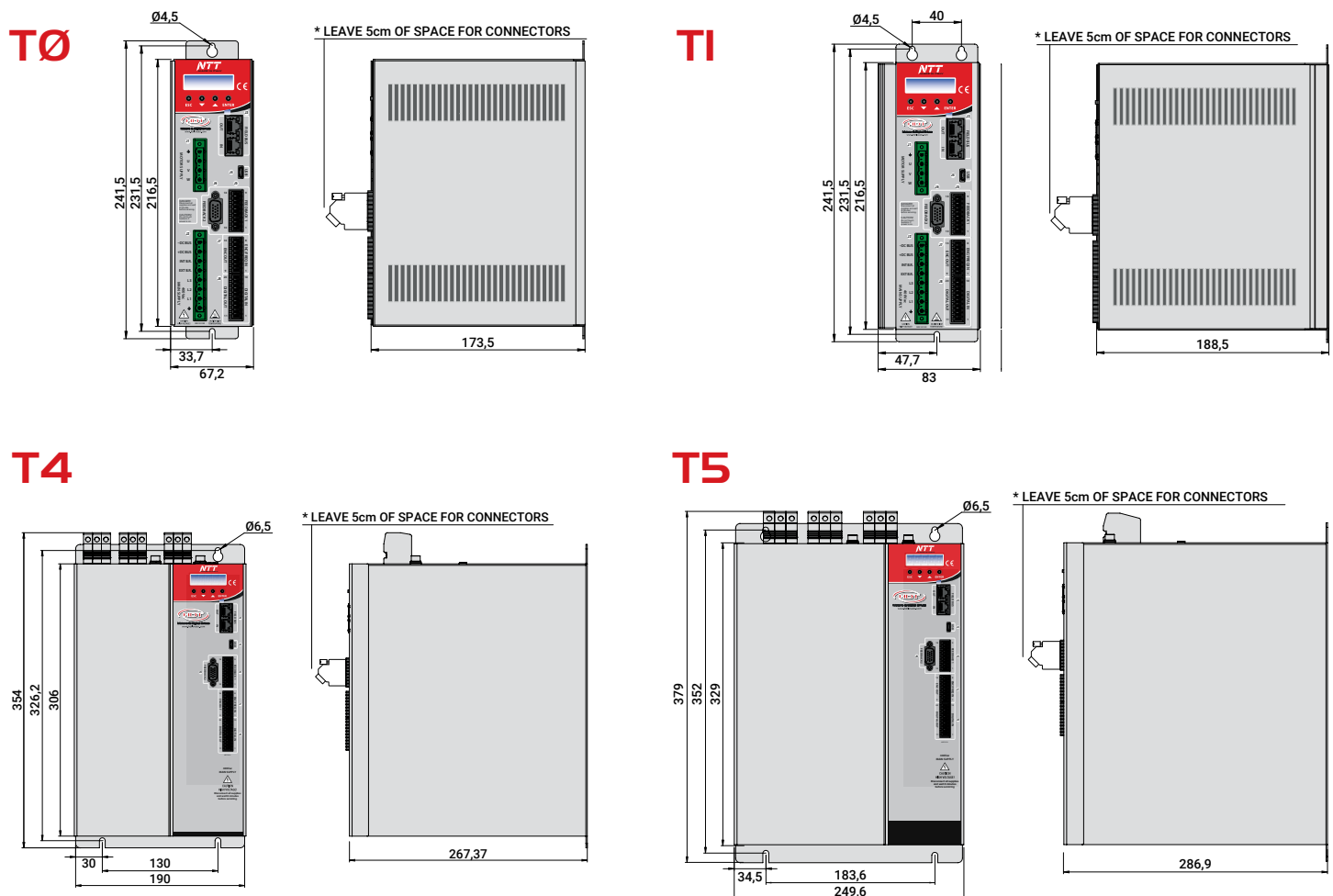

Measures in millimeters

Sizes in current and overall dimensions

NTT460

SIZES		1.5	3	6	10	20	35	45	75	100	150	200	
Power supply	V_{AC}	400V _{AC} 3Ph											
Min/Max supply voltage	V_{AC}	400V _{AC} ±15% - 50/60Hz											
DC Min/Max supply voltage	V_{DC}	400 V _{DC} ÷ 700 V _{DC}											
Rated current	A_{rms}	1,5	3	6	10	20	35	45	75	100	150	200	
Peak current	A_{rms}	3	6	12	20	40	70	90	150	150	250	375	500
Rated output power	KW	0,9	1,5	3	5	10	17	22	40	60	90	120	
Internal braking resistor		NO	YES			NO							
External optional braking resistor output		YES											
EMC internal filter*		YES				EXTERNAL							
Logic supply	V_{DC}	24V _{DC} ± 20%											
Dynamic forced ventilation		NO				YES							
Dimensions		T0	T1	T2	T3		T4		T5	T6	T7		
Weight	Kg	1,8	2,4	2,6	5,5	5,5	12	12	14	26,2	27,8	34	
Safety functions		STO - Safe Torque Off: IEC61800-5-2:2007 - SIL3 Cat.0: EN61508:2001 (EN954-1:1996)											

* = (EMC 61800-3 cat.C3)

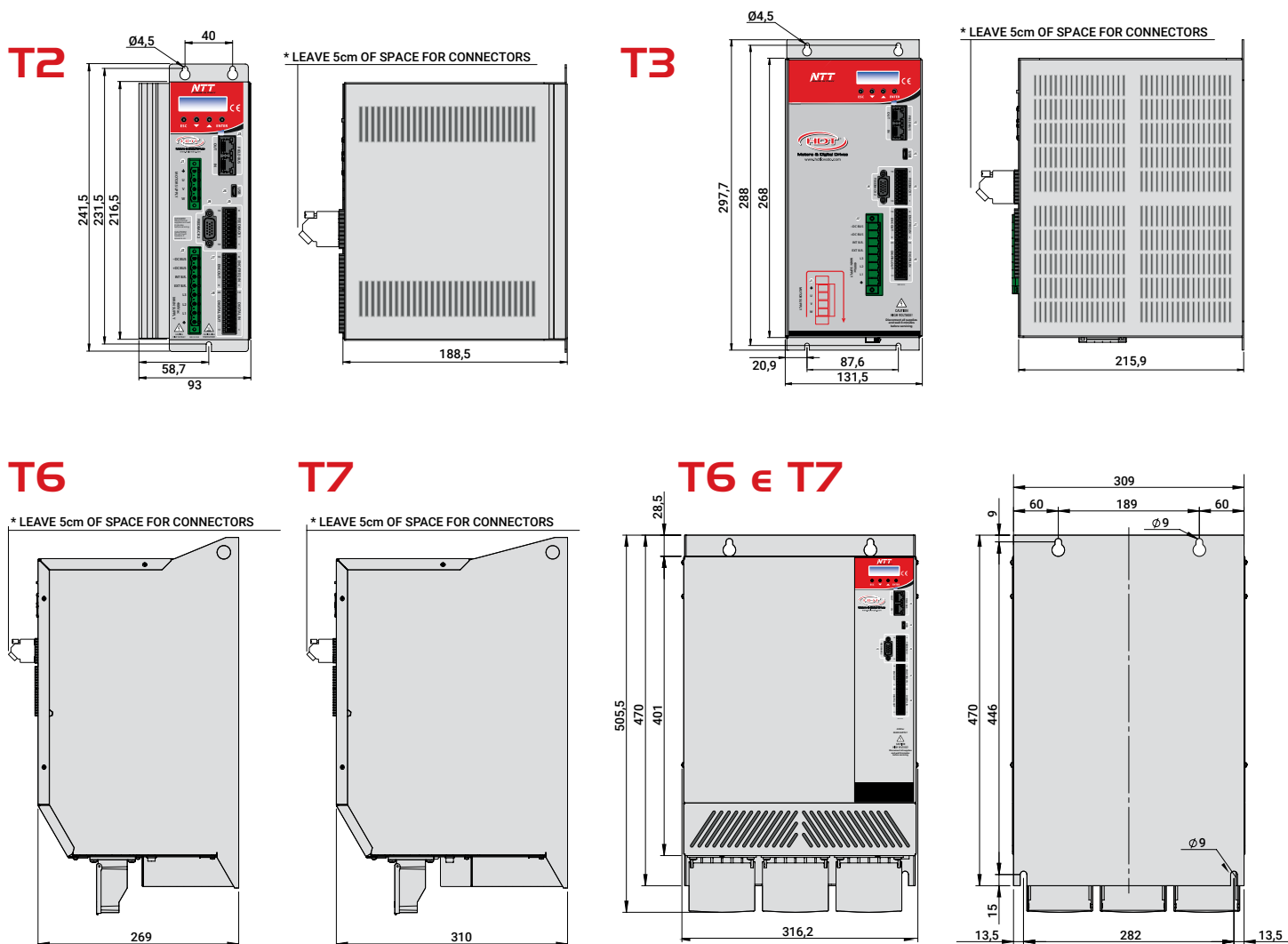

Servodrive technical specifications

Technical specification of NTT Servodrive		
Control method	Digital regulation loop for torque, speed and position	for AC brushless synchronous motor, rotary and linear: FOC control, SVM modulation, with feedback or sensorless.
		for rotary asynchronous motor: V/Hz and FOC control, SVM modulation with feedback or sensorless.
		for DC synchronous rotary brushless motor: trapezoidal modulation when using a feedback only from Hall sensors.
		for permanent magnet continuous current motor (rotary) with encoder feedback.
Main feedback	Hall's sensors	120° sequence.
	Encoder	Incremental 5V Line Driver with/without Hall sensors (adjustable power supply form 5 to 9V) Absolute Enc. SSI (adjustable power supply form 5 to 9V)
	Sensorless	Sensorless FOC and V/Hz
Second optional feedback	Resolver	16 Bit with simulated encoder 5V Line Drives
	Encoder	Hyperface + Sincos* Abs. Enc. SSI + Sincos*
Main analog reference		±10V differential speed and torque 16Bit
Auxiliary analog reference		±10V differential speed, torque and position 12Bit
Frequency reference	Speed and position	Pulses and direction (2MHz) Incremental encoder A/B (2MHz) CW/CCW (2MHz)
Encoder output	Simulated encoder	for resolver feedback: possibility to select 256, 1024, 4069 or 16384ppr (5V Line Drive)
	Repetition	ABZ channels repetition of the main feedback Frequency reference repetition
Control mode	Speed	Speed with/without torque limit. Adjustable trapezoidal or "S" ramps.
	Torque	Torque control
	Position	Multi-positioner: single target, from cyclic/acyclic table, analog Electronic gearbox: references from CW-CCW, A/B channels and puse/direction Electronic cam: referecnes from CW-CCW and A/B channels
	Pressure	Pressure control
Optional fieldbuses		Modbus RTU CanOpen CiA402 EtherCat CoE (CiA402) ProfiBus ProfiDrive DP V0 ProfiNet RT and IRT (CC - C)
Configurable inputs and outputs	Input	8 digital inputs PNP (2 Touch Probe) 3 analog inputs
	Output	6 digital outputs PNP 2 analog outputs 1 relay contact output
Digital filters		Observer on motor feedback. Notch filter on current reference. Iq filter on motor quadrature current. Low-pass filter on igital and analog inputs.
Drive and motor protection function		Shortcircuit Over/Undervoltage Missing phase and AC power supply I/O Power Failure Overtemperature of the heatsink (dynamic management of ventilation) Motor thermal image PTC management Thermal image of braking resistor. Resolver or Encoder/Hall's sensor breakdown Current limit
Drive interface		5 digits display and keys for displaying and managing the status of the drive and its parameters
Hardware Safety function		STO - Safe Torque Off: IEC61800-5 - SIL3 Cat.0: EN61508
Software Safety functions		Fault Reaction and Emergency Stop modes: Inertia Stop - Ramp Stop - Torque Limit Stop Braking in torque limit in case of a limit switch.
Braking management		Integrated brake management with immediate or ramp stop DC braking for asynchronous motors*
Drive parametrization		Via CALIPER 4.0 software through the microUSB port
Additional features		Motor autophasing procedure available for every type of feedback. Cogging compensation for brushless motors.

*= under development

Position transducers

The NTT servodrive is equipped with several inputs for the reading of position transducers. A standard main input that allows to read incremental and absolute SSI encoders. A second input dedicated to the reading of a second external incremental encoder or for a frequency-direction signal from PLC. A third optional input that can be chosen between Resolver or other absolute encoders and to use both for motor control and for the acquisition of the signal of an external feedback placed on the application. The transducers mounted on the motor gives to the servodrive the

information to control exactly the motion of the motor. The NTT drive can control both rotary and linear motors and therefore capable to read both transducers for rotary and linear motors of various types.

The NTT drive also allows to control sensorless rotary motors, but this use is limited to "motion control" applications that don't need accurate positioning. Most of "motion control" applications need an accurate control of the axis, and therefore they rely on position transducers with high precision, repeatability and robustness characteristics.

Resolver

The NTT drive allows as an option to read a feedback from a resolver. The resolver is a electromechanical device used in rotary application to detect the speed, the direction and the position of a rotary shaft. Rotating together with the shaft, it develops a sinusoidal signal that is detected and converted in digital from the NTT servodrive granting a precision of 16 bits. NTT can

generate the signal of an emulated incremental encoder with selectable resolutions of 256, 1024, 4096 and 16348ppr.

The resolver for its physical structure is certainly the most suitable transducer for heavy work environments and for this it is a favorite

Incremental encoder with Hall sensors

The NTT servodrive in his standard configuration allows reading Incremental Encoders with or without Hall sensors. The Incremental Encoder is an optoelectronic device applied to the motor's rotor that develops square-wave signals proportional to the angular shift of its rotary axis that is given back to the drive to manage both the motor and the application. The encoder provides an information of relative position, not absolute, and therefore is

always necessary an "homing" procedure to define an absolute position of the system. The signal generated is sent to the drive that performs the count and extrapolates, according to frequency, space, speed and acceleration data needed to control the motor. The resolution depends on the sensor and is measured in PPR, that is "pulses per round". Usually, HDT motors use incremental encoders with 2500ppr.

Absolute encoder SSI

The absolute encoder is designed to provide an information of absolute position on the single turn or on the multi-turn; mechanically, the working principle is similar to an incremental encoder, which have a univocal code written on a disk that allows to identify every angular position of the axis. Therefore it is always possible to know exactly the position of the axis even when stationary, without the necessity to perform an "homing" procedure to define the absolute position. The digital signal sent to the drive or to CNC is

a serial protocol. SSI is the open serial protocol handled by NTT drive. The resolution of absolute encoders is usually defined in "counts per revolution". The encoder for multi-turn information can use a mechanical system (more reliable and expensive) or it can memorize the number of turns on a memory supplied by a battery.

HDT uses an SSI mechanical absolute encoder with 17 bits of resolution (131072 cpr) on the single turn and 12 bits (4096 turns) on the multi-turn.

Safety circuit S.T.O.

The Safe Torque-Off (STO) feature of NTT drive is made of a redundant electrical circuit designed to bring a drive to a safe state of torque absence. It is a feature used to prevent unexpected motor rotation in case of emergency without the necessity to interrupt power supply. When STO function is active, the servodrive and the motor are in a state of functional safety, which means that is impossible to cause an active rotation of motor shaft or, if it is already rotating, the rotation stops by inertia.

The safety circuit implemented in NTT drive is manufactured and certified according to IEC EN 61800-5-2, with category 0 safety stop, and according to IEC61508 for SIL3 level.

The safety stop category 0 is achieved with the immediate disconnection of electronic components (IGBT) responsible of system energization, that cause an uncontrolled stop of the axis, by inertia.

It is usual, in the applications where there isn't a drive equipped with STO, to secure the system interrupting the power supply using a power contactor of adequate capacity. Using a STO it is possible to eliminate the power contactor with economical benefit, space saving in the cabinet and achieving a higher level of security integrity.

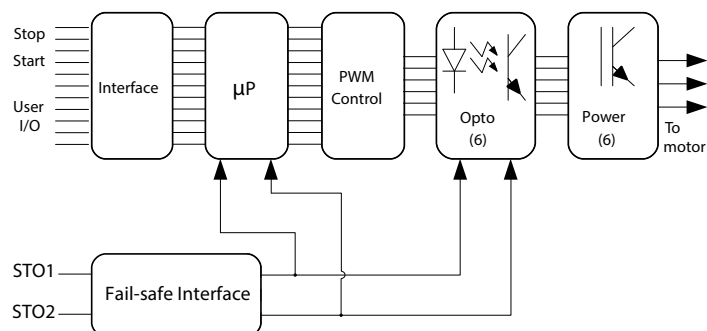

Optional fieldbuses

With the name "fieldbus" is identified a series of protocols for industrial networks, standardized in IEC 61158, used for control and communication in real time of a complex automated system. A complex industrial automated system, for example an automated line of biscuits production, in order to work needs to exchange information with different priority levels and timing between different parts that compose the system, for example HMI, PLC, sensors and servodrives. While the interpolation on many axis requires drive synchronization with timing less than 1ms, the positioning management just requires 10ms, and to send the information of position reached to be displayed on HMI it is possible to wait 100ms. So the different fieldbuses use rules to grant the "determinism" and

the "isochronism", or respectively the ability to provide a request in a limited time known to prior (maximum known latency) and to grant a strictly repetitive behavior over time (low jitter). Historically, the fieldbuses were born around a serial hardware structure like RS485. Among the most known fieldbuses there are ModBus, CanOpen and ProfiBus. In the last years, Ethernet-based bus, such as EtherCat and ProfiNet, have imposed themselves, preferred because to the higher speed and lower costs of Ethernet components. The NTT servodrive offers a wide range of fieldbuses both serial and Ethernet like RTU and TCP*, CanOpen CiA402, Profibus DPV0, EtherCat CoE, ProfiNet RT and IRT.



EtherCAT®

- ETHERCAT / COE**
- CiA 402 protocol**
- Electronic Gear
- Position Mode
- Velocity Mode
- Profile Velocity Mode
- Profile Torque Mode

- Homing Mode
- Interpolated Position Mode
- Cyclic Sync Position Mode
- Cyclic Sync Velocity Mode
- Cyclic Sync Torque Mode
- Touch Probe
- Pressure Control

CANopen®

- CANOPEN**
- CiA 402 protocol**
- Electronic Gear
- Position Mode
- Velocity Mode
- Profile Velocity Mode
- Profile Torque Mode

- Homing Mode
- Interpolated Position Mode
- Cyclic Sync Position Mode
- Cyclic Sync Velocity Mode
- Cyclic Sync Torque Mode
- Touch Probe
- Pressure Control

Modbus

- MODBUS**
- RTU Protocol**
- Speed control
- Torque control

- Electronic gear
- Multi-positioner
- Electronic cam
- Pressure Control

PROFI BUS®

- PROFIBUS DPV0**
- Profidrive Protocol**
- Speed control
- Manual positioner
- Pressure Control

PROFI NET®

- PROFINET RT and IRT (CC - C)**
- Profidrive Protocol**
- Speed control (AC1)
- Positioner in Program Mode (AC3)
- Manual positioner (AC3)
- Isochronous Control (AC4)
- Pressure Control

*Under development - contact HDT for availability

Optional fieldbuses

EtherCat CoE

The EtherCAT protocol is a standard for data exchange in industrial automation, generally defined as "fieldbus", of "open and realtime" type with high performances that uses the Ethernet hardware standard but with a different working principle in data exchange, defined as "on-the-fly".

In particular the standard Ethernet data pack (frame based on IEEE802.3) is no more received, interpreted and copied like a data process in every node. A master with a standard ethernet hardware send the telegrams to slave EtherCAT devices, equipped with modified ethernet hardware. These read the data addressed to them while the telegram passes through the device, processing the data "on-the-fly" and at the same time the input data are inserted

while the telegram passes.

Among the different protocols on Ethernet hardware, EtherCAT offers the absolute best realtime performances, being able to elaborate up to 1000 I/O in 32.5 μ s or 100 axis in 125 μ s.

EtherCat supports the CiA402 profile of CANopen (CoE), and therefore, in terms of application, users who already use drives in CANopen will find the same variables and parameters they are familiar with.

Very high performance, economy of Ethernet technology and adoption of the CanOpen CiA402 profile made it in a short time the most widespread ethernet fieldbus in the industrial automation devices.

CanOpen CiA 402

The CanOpen protocol, acronym of Controller Area Network, is an open deterministic fieldbus "real-time" based on serial hardware. Designed to work on environments where is required an high immunity level, the bit rate can reach 1Mbit/s for networks shorter than 40m and uses as means of transmission a differential line. Different profiles exist for different applications.

In particular, the CiA402 profile define and standardize the functional behavior of controllers for servodrives and allows both interpolation and point-to-point operations. The bus, born over 25 years ago, is defined and managed by CiA IG (Can in Automation Interest Group).

ModBus RTU - TCP

The Modbus is a serial communication protocol (default RS485, but also RS232) of open type created in 1979 to put in communication PLC's with electronic industrial devices.

It is wide spreaded and cheap to handle, although it does not boast great speed it suits itself very well to give commands with time of about 20ms. Modbus allows the communication between different devices connected to the same network and it

is often used to connect a supervisor HMI with a remote terminal unit (RTU) in supervision control and data acquisition system (SCADA).

HDT manage the Modbus protocol RTU type, widely used in industrial automation, and TCP type that is really similar to Modbus RTU, but it sends protocol data inside TCP/IP data type.

ProfiNet RT and IRT

ProfiNet (acronym of Process Field Net) is a fieldbus "open and real-time" based on standard Ethernet technology according to IEEE802.3 suitable for data management in an industrial environment.

ProfiNet was developed in 3 profiles, divided by field of use, performance and complexity.

The ProfiNet NRT (No Real-time) profile for application where timing is not critical that uses standard TCP/IP and UDP/IP protocols used for parametrization, configuration and acyclic read and write operations that reach cycle time >100ms.

The ProfiNet RT (Real Time) deterministic profile, used for standard

cyclic data transfer . The data transfered via RT bypass the TCP/IP interface to accelerate data exchange with PLCs, allowing to create applications with cycle times < 10ms. This profile is comparable as functionality to Profibus DP V0.

The IRT profile (Isochronous Real-Time) is the high-speed protocol used for Motion Control applications and requires, as the EtherCat, of a Ethernet modified with a custom ASIC.

This profile allows cycle times <1ms.

HDT developed the RT and IRT protocol in classes AC1, AC3, AC4.

Profibus DP V0

Profibus (Process Field Bus) is a standard of serial communication of deterministic type for devices inserted in automation networks. It is an open protocol, defined by DIN 19245.

Composed of three communication profiles and among them the DP(Decentralized Peripherals) is the one dedicated to work with PLC and I/O, capable of operating at a bit rate from 9.6 kbit/s to

12Mbit/s with distance between nodes that can go up to 300m with standard cable at maximum exercise speed.

The DP V0 version of Profibus is suitable for cyclic data exchange and diagnostics, resulting as one of the most widespread in industrial automation sector.

Software tool: Caliper

CALIPER is the software tool designed to simplify the calibration of your servodrive and motor with Microsoft Windows operating systems. A specific graphic interface extremely intuitive speeds up and make it even more simple to access the full range of functions of all the HDT servodrives. In addition to selecting the applications, save and load data, Caliper includes a powerful

professional oscilloscope, autophasing tools, automatic cogging reduction, observer for vibrations, fieldbus analyzer and many other applications to help you tune your applications at best. The communication is via Micro USB 2.0 port, and therefore it doesn't need special cables or serial converters.

MAIN FEATURES:

- Drive configuration
- Reading, loading and saving of drive parameters
- Possibility to connect via USB Hub different drives and to control them simultaneously from Caliper selecting the specific drive.
- Oscilloscope with 4 configurable channels with the possibility register, save and print the measures taken
- Motor autotuning and autophasing
- Selection and configuration of operative mode:
 - Torque control
 - Torque limit control
 - Speed and positioning control
 - Multi-positioning
 - Electronic Axis
 - Electronic Cam
 - Pressure Control (hydraulic press)
 - Filters
 - Display Alarms

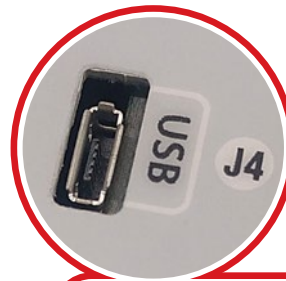

Micro USB 2.0 port

Data sharing.

Caliper allows to save and recharge data for axes tuning and/or motor data. All data can be printed and sent by email

Index/N°	Posizione	Velocità	Accet.	Decel.	Tempo	Ass./Real.	Modo vel.	Impost. pos.
1	0	1000	10000	10000		0	Assoluta	Dati tab-rec
2	32768	3000	10000	10000	200	Assoluta	Dati tab-rec	Unione pos succ.
3	-32768	1000	10000	10000		0	Assoluta	Dati tab-rec
4	655360	3000	10000	10000		0	Assoluta	Dati tab-rec
5	-655360	1000	10000	10000		0	Assoluta	Dati tab-rec
6	1499	1000	10000	10000		0	Assoluta	Dati tab-rec
7	150000	1000	10000	10000		0	Assoluta	Dati tab-rec
8	738900	1000	10000	10000		0	Assoluta	Dati tab-rec
9	40003650	3000	10000	10000		0	Assoluta	Dati tab-rec

The graph displays a cam profile with the following data points:

N°	Punti cam
1	64
2	64
3	64
4	64
5	64
6	64
7	64
8	64
9	64

The Data Monitor window displays various parameters for monitoring, including:

- Vel. [rpm]
- Cur. [A]
- Pres-Ref [bar]
- Pres-Mes[bar]
- Pos.

Software tool: Caliper

4-channel digital oscilloscope in real time

Flagship of Caliper software from the beginning, the new 4 channels oscilloscope allows to sample signals at 100 μ s via the fast Micro USB 2.0 port. All channels are selectable, recordable, savable also as picture or PDF format.

A convenient wave function generator feature is available, useful to perform the tuning of control loop without having to physically remove the axes. Data gathered during observation can be saved and printed in order to be shared or stored.

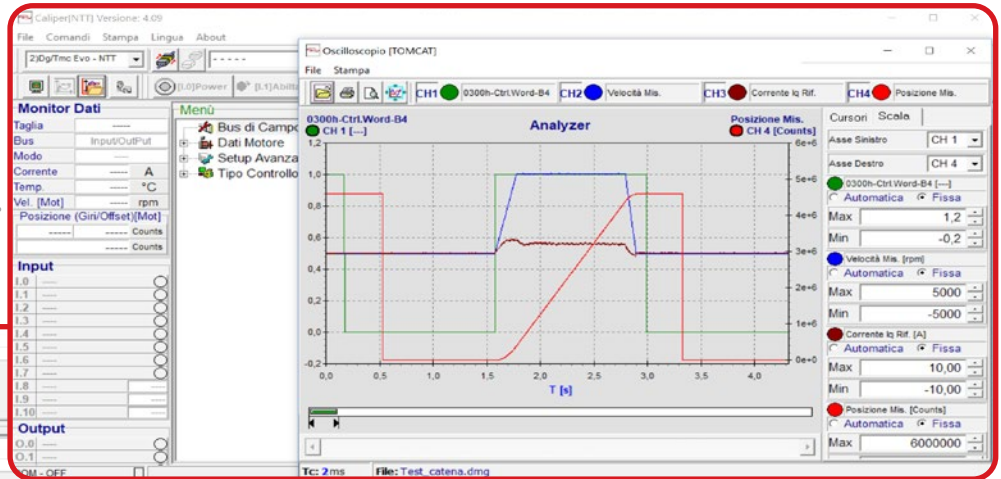

Choice of application and parameterization

The usage of block diagram and graphical representations of applications simplify the parametrization.

Intuitive Interface.

Clear and logic interface, off-line data input, multi-language mode (english, italian, french, turkish and chinese), simplify the navigation in menus and commands. Important parameters accessible only with password. "Operator enable" security function to avoid accidental manumissions.

Pressure control for servopump systems

The NTT servodrive integrates an operative mode called "pressure control", designed expressly for applications that use servo-pumps like in presses and plastic injection machine, which are applications that combine an idraulic system with an electrical regulation via servodrive and brushless motor.

By activating this mode on NTT servodrives, tre inputs are enabled. The first input for the speed reference signal is used to regulate the speed of a motor connected to a pump, and so the respective flow. A second input is enabled to receive the pressure reference signal, and a third input is enabled for the pressure transducer signal (pressure feedback). The two pressure signals are compared and the servodrive operates the control of speed to maintain the real pressure equal to the reference.

The pairing of NTT with a brushless servomotor thanks to this application allows to replace a traditional system wiht pump and asynchronous motor, obtaining an incredible benefit in the system efficiency.

Energy consumption is drastically reduced, oil temperature is reduced, idraulic system is simplified thanks to the elimination of proportional valve and the pressure and flow control is improved,

that are reflected on the product quality.

Control system with minimal response times that allow a very accurate control with considerable improvement in the accuracy of moulding process.

The drastic energy saving is due to the fact that NTT allows to stop the motor maintaining the system pressure with a near-zero power consumption, while in the traditional systems with asynchronous motor , the motor heve to rotate at fixed speed around 1500rpm to maintain the system pressure even if the application is not working. As a consequence, a pump equipped with NTT is managed with variable speed and allows to reduce the heating compared to a circuit that constantly works at fixed speed, even if only to maintain pressure. This improves that oil circulation in the system that is maintained at low temperature, allowing the installation of radiators with small dimensions. The servodrive allows to achieve the maximum repeatability in flux regulation granting a better quality of the product.

Furthermore, among the motors, the brushless is the one with higher efficiency, with values around 95%. Not least, the system is much more silent and with lower size.

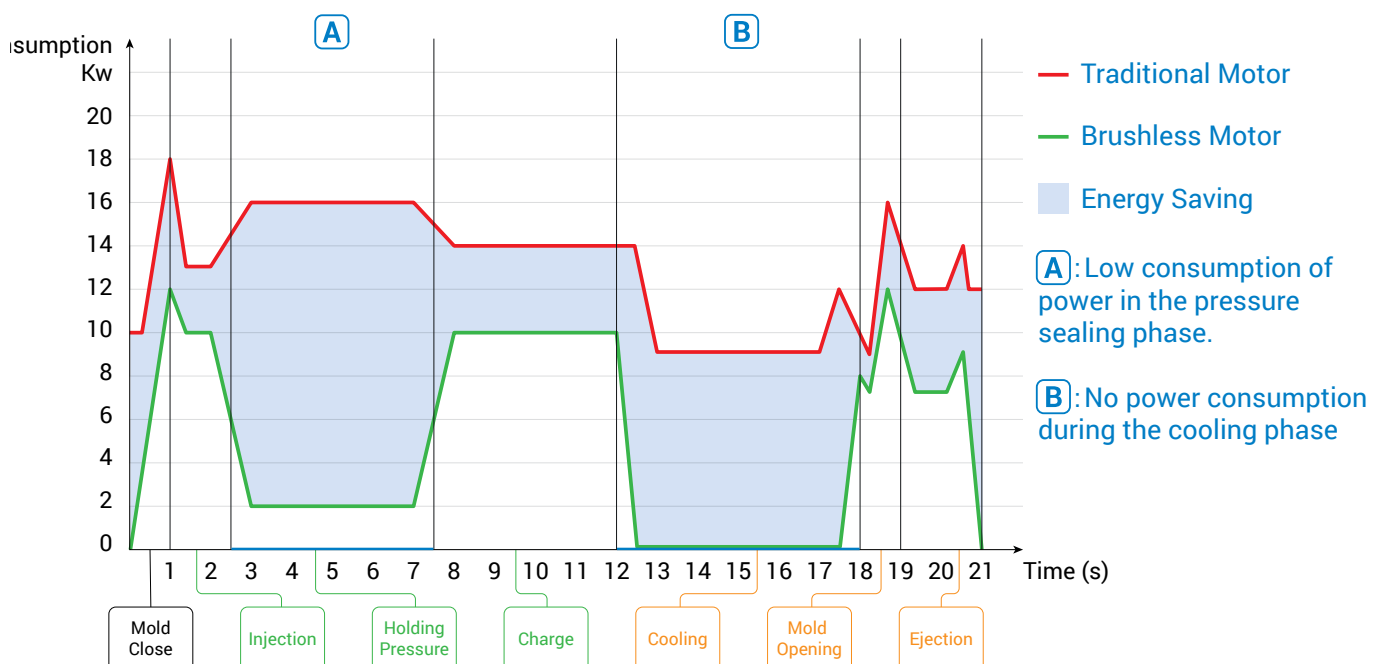
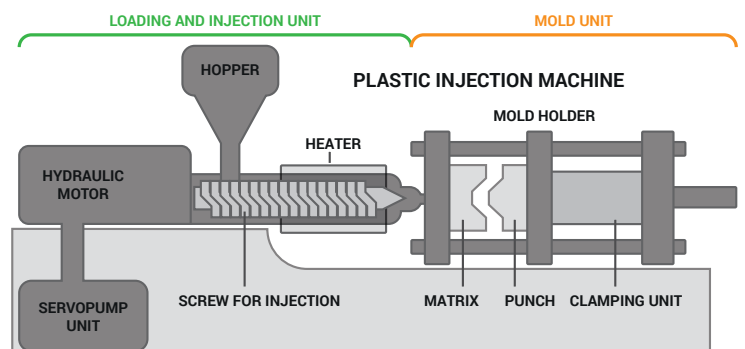
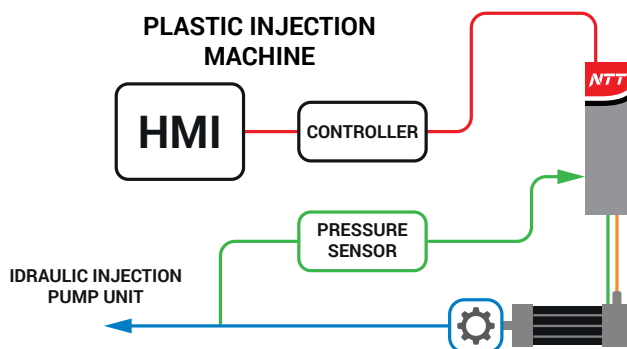

Control methods and application

Position Control: Electronic Axis

The electronic axis (electronic gear) is a standard feature of NTT servodrive that allows to set a transmission ratio between one or more motors, where a slave axis, or "follower", follow a master axis according to a preset ratio. This ratio is set in the slave drive and can be modified at will. The movement of the master is measured with an encoder, which signal is sent to the input of the follower drive, that follows according the set ratio. The electronic axis replicates the mechanical transmission principle, in the same way that happens in a reducer, recirculating ball screw, a rack or a pulley and belt system. The transmission with mechanical

reduction allows to change speed, to increase torque and helps to reach the match of inertia between motor and load. The electrical axis function, compared to mechanical reduction, only regulates the speed but with the advantage of allowing to change on will and to eliminate backlash and deterioration typical of mechanical systems. It is possible to connect different slave axes to a single master axis, with different electrical gear ratio. When managing the electrical axis, It is important to calibrate the parameters of slave axis, especially response times.

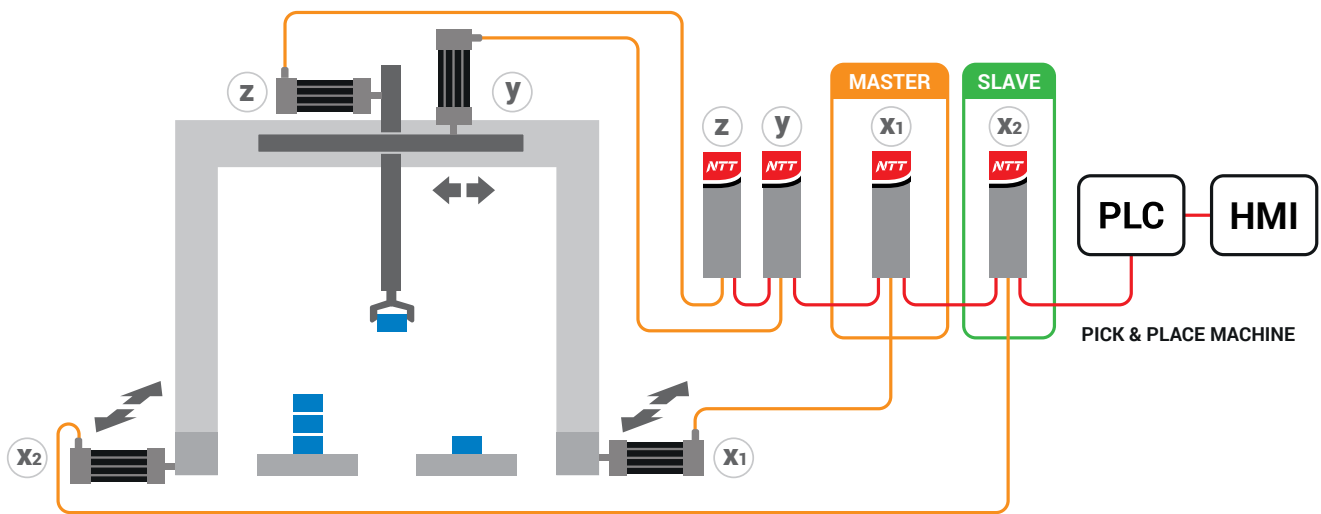

Electronic Cam Control

The electronic cam is a feature that replicate the concept of mechanical cam. The mechanical cam is an element with irregular shape (typically ovoid) fixed to a rotating shaft of an axis and which moves another mechanical parts that follows and reproduces the profile.

In the electronic cam, the mechanical regulation is replaced with electronic. A cam profile is defined via a X/Y table with a maximum of 576 interpolable points

Unlike the mechanical cam, where the cam profile is fixed to master axis, in the electronic cam the profile is inserted in the servodrive

that drives the follower motor.

The "slave" axis receive the space reference of the "master" axis and replicate the profile described in the table of X/Y points, generating the resulting motion.

The signal of the master axis can come from an external encoder or from the signal of a simulated encoder of a servo axis.

The benefit of the electronic cam compared to the mechanical one is evident in the flexibility to manage more than one profile, to be able to modify the profile very easily in any moment and not least the reduction of mechanical backlash and the corresponding adjustments that follow.

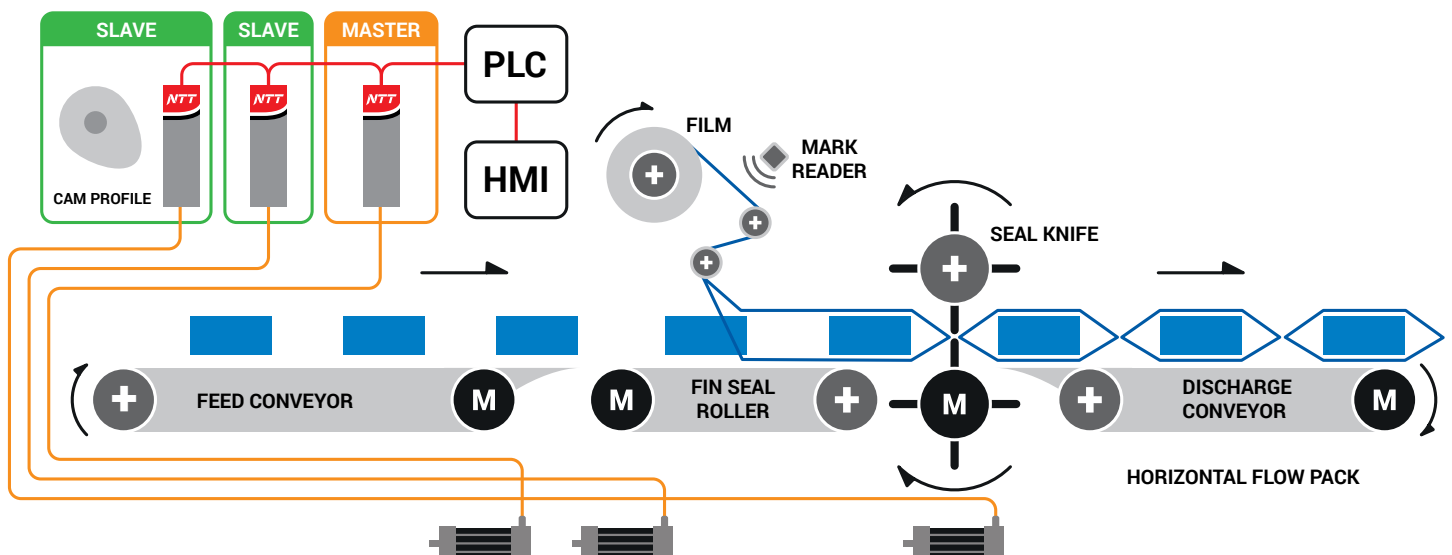

Position Control: Multi-positioner

The NTT servodrive integrates a "multi-positioner" operating mode with 4 selectable modes.

The positioner application generates a speed profile to reproduce a motion trajectory with controlled acceleration and jerk, allowing accurate positioning. The profile calculation is performed in real time allowing to modify on-the-fly the position target with time lower than 1 millisecond. This allows to manage in a fast way different motion profiles.

The positioner includes a functionality called "stop on marker" that allows to perform a controlled position stop when a sensor signal is detected by a digital input of the drive during the execution of the trajectory.

Single target positioner.

This mode can be activated both with digital/analog input and with all fieldbuses.

The drive configured in this way allows to generate a trajectory profile only for a target defined as position target, with speed, acceleration, deceleration and jerk. The positions can be absolute or relative.

Using the fieldbuses, all parameters can only be set on the fly by telegram; only the Modbus RTU allows to work with maximum flexibility using both modbus commands and digital/analog input commands.

In case a fieldbus is not available, position and speed can be set in analog mode via the respective input, while the other parameters can be set via Caliper software.

Positioner with table of targets.

This mode can be activated both with digital/analog inputs and

with Modbus RTU and ProfiNet RT.

The positioner allows to manage a maximum of 64 targets. As with the single target, for each target it is possible to set position, speed, acceleration and jerk. The positions can be absolute or relative.

The targets are wrote in a table on the drive via Caliper or via fieldbus. The targets can be executed individually or linked in different ways allowing to generate more complex profiles.

It is possible to cycle automatically the series of linked targets and to interpose a waiting time between one target and the other.

Cyclic positioner.

This mode is similar to the positioner with target from table, with the difference that the targets are strictly executed one after the other. The targets can be activated manually via I/O or via Modbus RTU.

The option to make the sequence of set dimensions cyclical is provided.

"Input-start" positioner.

This mode allows to synchronize the starting of an axis with the reaching of the position of another axis, without the necessity to use a PLC. It is different from the previous one because the input that selects the target or the group of linked targets also becomes the start command of the target itself. The "reached position" signal can be activated on each of the digital output of the drive.

Therefore, connecting one of the output of reached target of a NTT servodrive with the input of another NTT servodrive, it allows the synchronized starting of the latter.

This mode only works with digital/analog inputs and with Modbus RTU fieldbus.

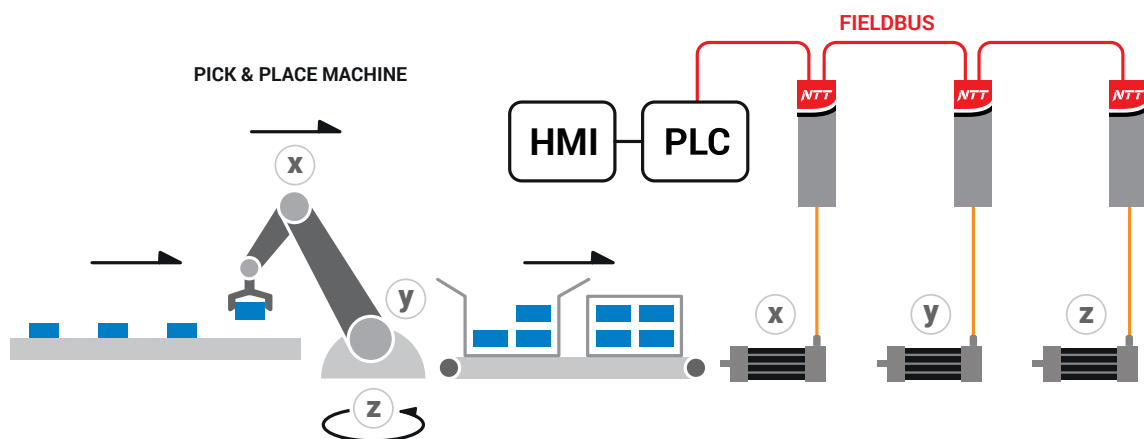

Speed control and torque limit

The speed control is a mode that allows to control the speed of the motor via a speed reference, managed by an analog input, a frequency input or a fieldbus command. In I/O or Modbus mode it is possible to use an additional analog auxiliary speed reference or torque limit reference.

Therefore, it is possible to work in speed control mode, limiting the maximum torque output by imposing a limit threshold.

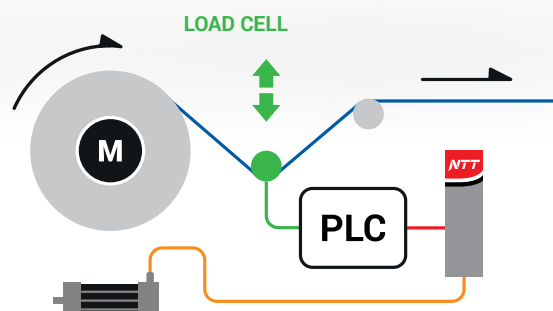

Control method and application

Torque Control

The torque control is a mode that allows to control the torque provided by the motor thanks to a torque reference managed by an analog input or a command sent via ModBus, CanOpen EtherCat or Profibus.

The torque reference that is provided is proportional to the rated torque of the motor.

According to the type of reference you work with, in Caliper software it is possible to set different parameters, for example full-scale of analog input, optimal PID controllers for the application and the desired digital I/O.

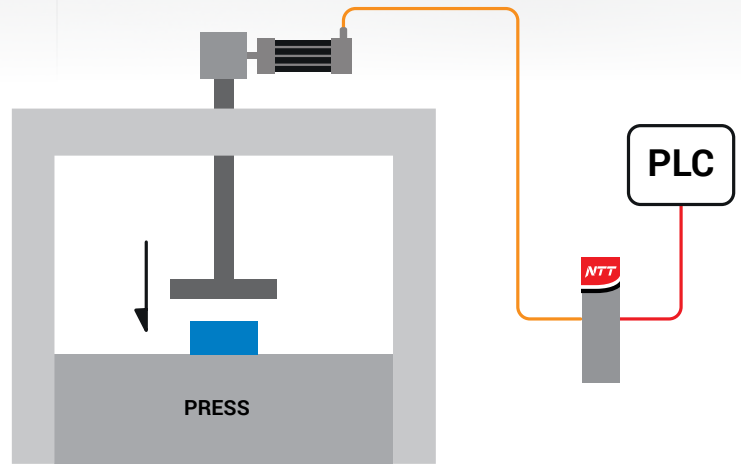

NTT Servodrive	Drive Configuration					
Control Mode	Analog Base	RTU Modbus	Canopen CiA 402	Ethercat COE	Profibus DPV0	Profinet RT - IRT
Speed	YES	YES	YES	YES	YES	YES
Torque	YES	YES	YES	YES	YES	YES*
Position	YES	YES	YES	YES	YES	YES
Electronic gearbox	YES	YES	YES	YES	NO	YES*
Electronic Cam	YES	YES	NO	NO	NO	NO
Pression	YES	YES	YES	YES	YES	YES
Touch Probe	NO	NO	YES	YES	NO	YES

* Under development

Order Code

Drive type:

Power supply voltage:

240 = 230Vac / 300Vdc

460 = 400Vac / 540Vdc

Fieldbus options:

ST = No Fieldbus

EC = EtherCat

PB = Profibus

CM = CanOpen/ModBus

PN = Profinet

Feedback options:

R = Resolver

(blank) = No Feedback Option

Size in current unit:

1 3	4 5 9 0
3 6	4 5 1 5 0
6 1 2	7 5 1 5 0
1 0 2 0	1 0 0 2 0 0
2 0 4 0	1 5 0 3 0 0
3 5 7 0	2 0 0 4 0 0

Versions:

(blank) = No versions

EXAMPLE: **NTT 240 36 CM R** NTT 230Vac - 3/6A - With CanOpen/Modbus option and Feedback Resolver option



Motors & Digital Drives

NTT0220UK

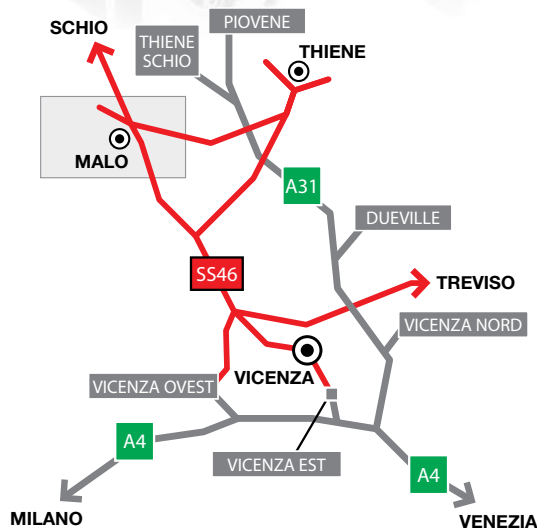
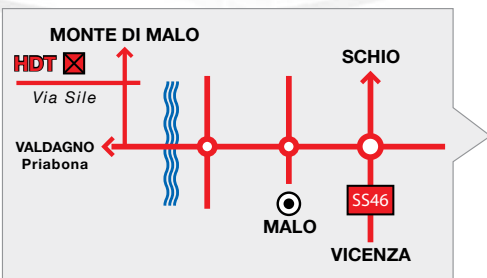

© HDT 2018. The information contained in this brochure is for guidance only and does not form part of any contract. The accuracy cannot be guaranteed as HDT have an ongoing process of development and reserve the right to change the specification of their products without notice.



H.D.T. srl - Via Sile, 8 - 36030 Monte di Malo (VI) Italy
Tel: +39.0445.602744 - Fax: +39.0445.602668 - Email: info@hdtlovento.com - www.hdtlovento.com